

S20

VitrA





# S20

## Vielseitige Nutzung durch zeitloses Design

Zeitgemäßes und innovatives Design ist neben wirtschaftlichen Aspekten und Langlebigkeit der Eckpfeiler der Linie S20. Die moderne Anmutung der Serie von Vitra Bad wird allen Ansprüchen an ein heutiges Bad gerecht. Die klare Formgebung schafft einen ästhetischen Wert, der sich stimmig in verschiedenste Anwendungsbereiche einfügt – sowohl im Privatbereich, in öffentlichen Räumen, Bürokomplexen als auch im Hotelleriebetrieb.

## *Various uses through timeless design*

*Contemporary and innovative design, in addition to economic aspects and longevity, are the cornerstones of the S20 line. The modern impression of the Vitra Bad series meets all the demands made on a present-day bathroom. The clear-cut styling creates an aesthetic quality which integrates itself harmoniously into a variety of application areas – both in a private environment, in public spaces, office complexes and in the hotel sector.*





## S20 Comfort

Ein Bad als Erlebnis. Mit der Serie S20 von Vitra Bad erleben Sie individualisierte Raumlösungen mit qualitativ hochwertigen Produkten zum Wohlfühlen. Ein privater Rückzugsort mit wohltuender Atmosphäre. Das zeitlose Design verkörpert den heutigen Anspruch an das moderne Lebensgefühl unserer Zeit und besticht zudem durch seine universelle Einsetzbarkeit.

*The bathroom as an experience. With the S20 series by Vitra Bad, you will experience customised space solutions with high-quality products for a sense of well-being. A private retreat with a soothing ambiance. The timeless design embodies today's demands of the contemporary lifestyle of our times and also captivates with its wide-ranging versatility.*







## S20 Comfort

1 Möbelwaschtisch, 85 cm, Unterschrank mit 1 Auszug, Eiche dunkel, Dekor  
*Vanity basin, 85 cm, vanity unit with 1 drawer, oak dark, decor*

2 In dem geräumigen Auszug können Handtücher, Kosmetik und Accessoires verstaut werden.  
*Hand towels, cosmetics and accessories can be stored inside the spacious drawer.*



## S20 Comfort

- 1 Wand-WC, WC-Sitz mit Absenkautomatik, Wand Bidet  
*Wall-hung WC, WC seat with soft closing mechanism, wall-hung bidet*
- 2 Spiegelschrank, 80 cm, mit integrierter Beleuchtung, 2 Glaseinlegeböden, Doppelsteckdose  
*Mirror cabinet, 80 cm, with integrated lighting, 2 glass shelves, double socket*



# S20 Basic

S20 erfüllt alle Anforderungen an einen zeitgemäß gestalteten Badbereich. Dabei spricht die Vielseitigkeit der Anwendungsgebiete für die praktische und funktionale Umsetzung der Linie. Mit den qualitativ hochwertigen Produkten lassen sich sowohl Privatwohnungen als auch Wohnanlagen wirtschaftlich ausstatten oder renovieren, ohne dabei auf gewünschten Komfort verzichten zu müssen.

*S20 satisfies all requirements for a bathroom area designed in a modern style. The versatility of the applications argues for the practical and functional implementation of this line. Private residences as well as housing estates can be furnished or upgraded with the high-quality products in an economical manner, without having to forego the desired comfort.*











3

## S20 Basic

- 1 Möbelwaschtisch, 65 cm, Spiegel, 60 cm, mit LED-Leuchte  
*Vanity basin, 65 cm, mirror 60 cm, with LED-lighting*
- 2 Waschtisch, 60 cm, mit Halbsäule  
*Washbasin, 60 cm, with semi-pedestal*
- 3 Wand-WC, WC-Sitz mit Absenkautomatik  
*Wall-hung WC, WC seat with soft closing mechanism*
- 4 Bodenebene Duschwanne, 90 x 90 cm, mit Mittelablauf  
*Zero to surface shower tray, 90 x 90 cm, with central outlet*



4

# S20 Guest

Das Gästebad als räumliche Visitenkarte. Dieses Aushängeschild einer Wohneinheit kann auch heute schon zeitlos und modern umgesetzt werden, ohne dabei die Wirtschaftlichkeit außer Acht zu lassen. Die Linie S20 bietet passende Lösungen für die Bedürfnisse Ihrer Gäste – auch auf kleinstem Raum.

*The cloakroom as a spatial calling card. This flagship of a dwelling unit can be realised already today in a timeless and modern fashion, without disregarding the cost-effectiveness. The S20 line offers suitable solutions for the needs of your guests – even in a minimum of space.*









## S20 Guest

- 1 Möbelwaschtisch, 65 cm, Unterschrank mit 2 Türen, weiß hochglänzend  
*Vanity basin, 65 cm, vanity unit with 2 doors, white high gloss*
- 2 Spiegel, 60 cm, mit LED-Leuchte und Ablage, weiß hochglänzend  
*Mirror, 60 cm, with LED lighting and shelf, white high gloss*
- 3 Wand-WC, WC-Sitz mit Absenkautomatik  
*Wall-hung WC, WC seat with soft closing mechanism*



# S20 Hotel

Ein Hotelbad hat einen besonderen Stellenwert: Intelligente Raumkonzepte, hohe Funktionalität und ästhetische Gestaltung entscheiden über die Zufriedenheit des Gastes. Hoteliers wünschen sich zudem Produkte mit Anspruch an leichte Handhabung und Langlebigkeit. Mit der Serie S20 ist Vitra Bad allen Bedürfnissen an ein modernes Bad für diesen Einsatzbereich gerecht geworden.

*A hotel bathroom has a special significance: Intelligent room concepts, a high degree of functionality and aesthetic design determine the satisfaction of the guest. In addition, hotel operators want products with the features of easy handling and durability. With the S20 line, Vitra Bad has fulfilled all the requirements for a modern bathroom in this area of application.*







## S20 Hotel

- 1 Einbauwaschtisch, 53 cm, mit Hahnlochbank  
*Countertop basin, 53 cm, with tap platform*
- 2 Einbauwaschtisch, 55 cm, mit Hahnlochbank  
*Countertop basin, 55 cm, with tap platform*





## S20 Hotel

1 Einbauwaschtisch, 55 cm  
*Countertop basin, 55 cm*

2 Unterbauwaschtisch 47,5 cm  
*Under-counter basin, 47,5 cm*

3 Wand-Bidet, Wand-WC, WC-Sitz mit  
Absenkautomatik  
*Wall-hung bidet, wall-hung WC, WC seat  
with soft closing mechanism*





## S20 Restroom

Bei der Gestaltung öffentlicher Sanitärbereiche nimmt die Einhaltung hygienischer Standards einen wesentlichen Bestandteil bei der Planung und Gestaltung eines Bads ein. Mit der Serie S20 ist Vitra Bad zudem ein langlebiges und zuverlässiges Produkt für die speziellen Anforderungen an einen solch sensiblen Bereich gelungen.

*In the design of public sanitary facilities, maintaining high standards of hygiene plays an important role in the planning and design of a bathroom. With the S20 series, Vitra Bad has also succeeded in creating a durable and reliable product for the special demands placed on such a sensitive area.*







## S20 Restroom

- 1 Wand-WC, WC-Sitz mit Absenkautomatik  
*Wall-hung WC, WC seat with soft closing mechanism*
- 2 Unterbauwaschtisch, 43 cm  
*Undercounter basin, 43 cm*
- 3 Urinal, Zulauf von hinten, ohne Spülrand, mit Spüldüse,  
Urinaltrennwand, Keramik  
*Urinal, back inlet, without rim, including jet nozzle,  
urinal dash panel, ceramic*







VitrA

Technische Seiten/*Technical Pages*

# Sanitärkeramik / Ceramic sanitaryware

5500L003-



0001

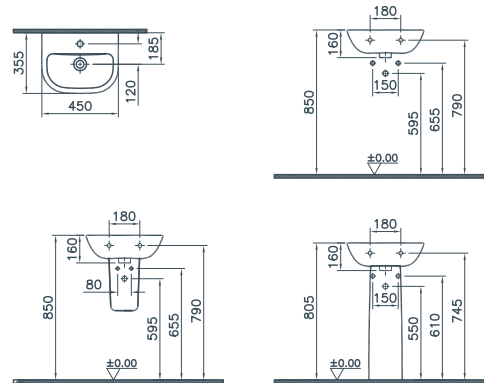

5501L003-



0001

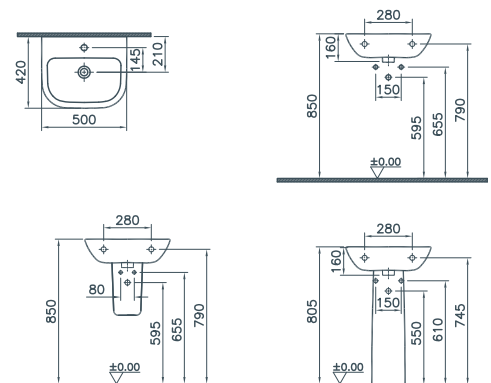

5502L003-



0001

0041

0012

0016

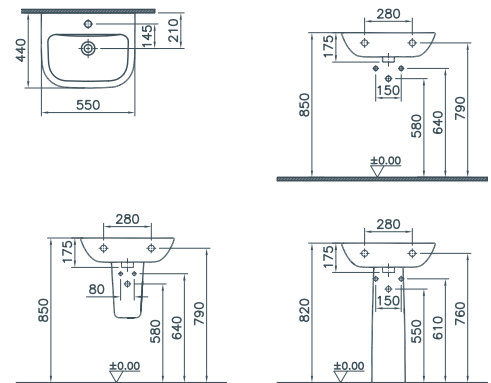

5503L003-



0001

0041

0012

0016

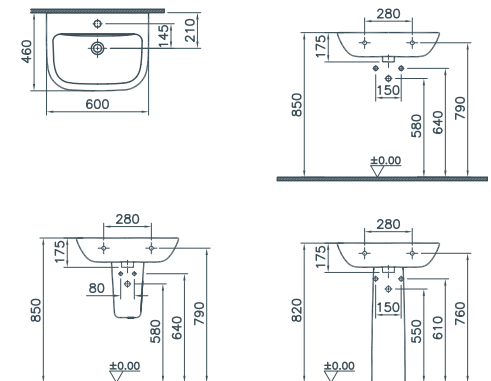

# Sanitärkeramik / Ceramic sanitaryware

5504L003-



- 0001
- 0041
- 0012
- 0016

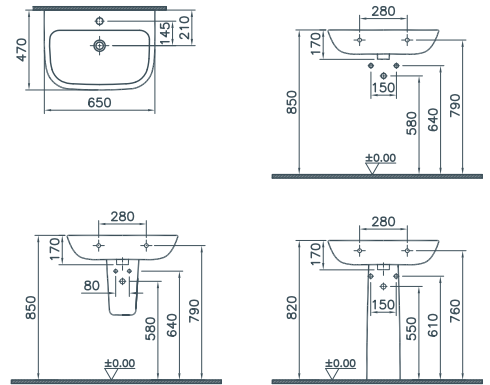

5463B003-



- 0001

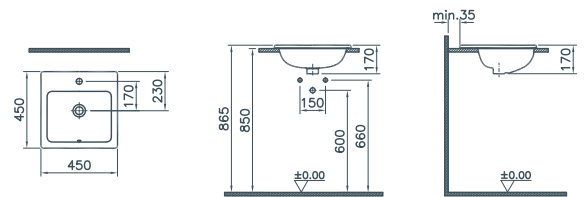

5464B003-



- 0001

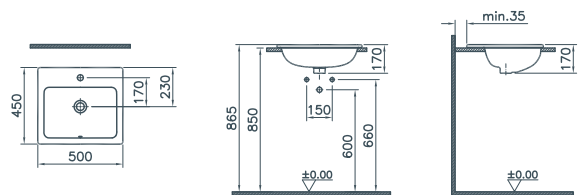

5465B003-



- 0001

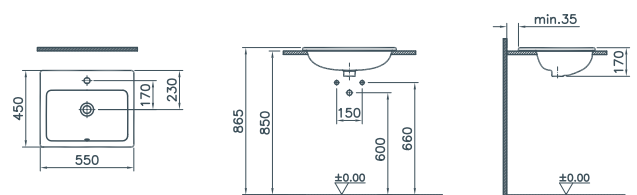

5473B003-

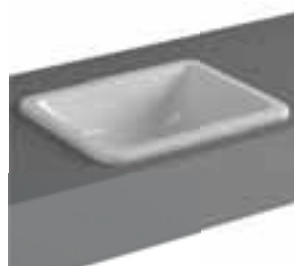

- 0642

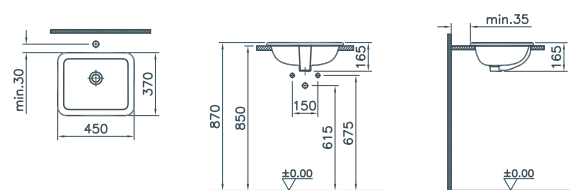

# Sanitärkeramik / Ceramic sanitaryware

5474B003-



0642

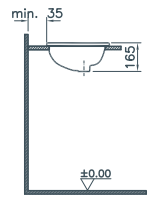
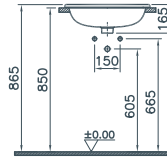
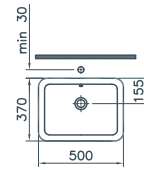

5475B003-



0642

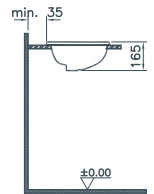
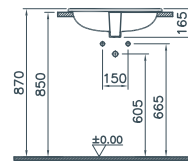
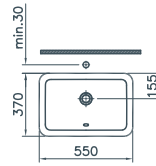

5466B003-



0001

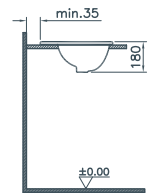
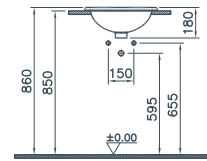
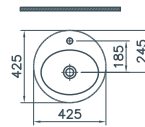

5467B003-



0001

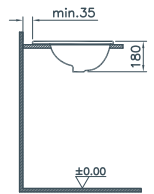
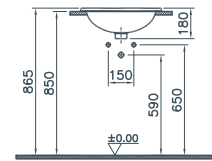
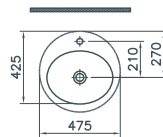

5468B003-



0001

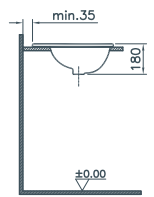
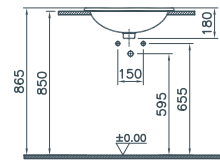
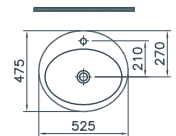

# Sanitärkeramik / Ceramic sanitaryware

5473B003-



0618

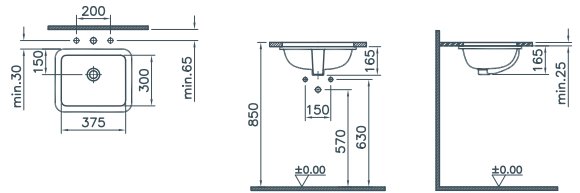

5474B003-



0618

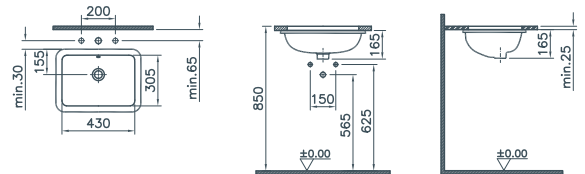

5475B003-

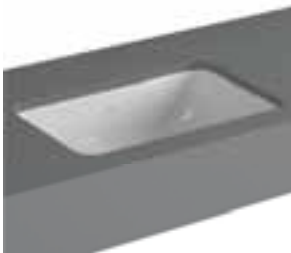

0618

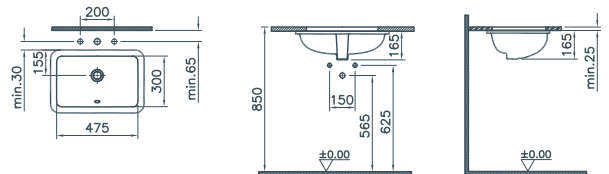

5524B003-



0001

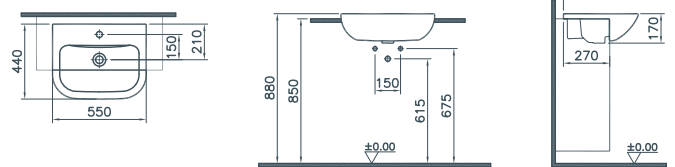

5522B003-



0001

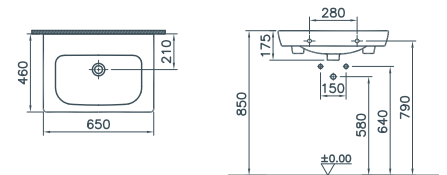

5523B003-



0001

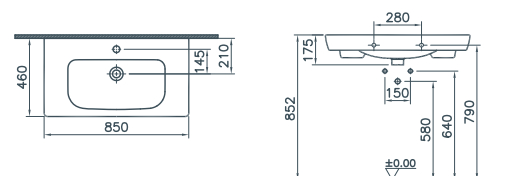



# Sanitärkeramik / Ceramic sanitaryware

5291B003-



- 0001
- 0041
- 0012
- 0016

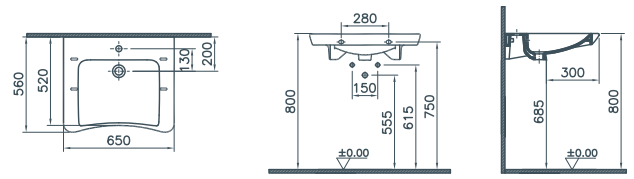

5505L003-



0075

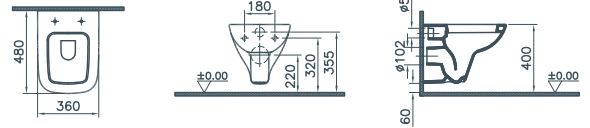

5506L003-



0075

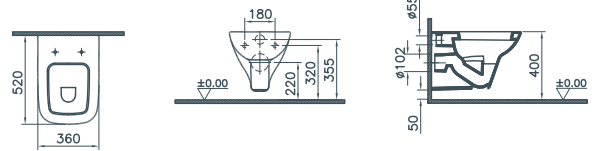

5507L003-



0075

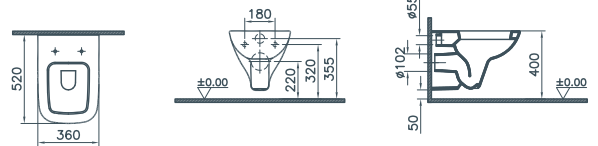

5516L003-



0075

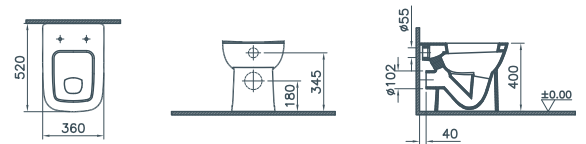

# Sanitärkeramik / Ceramic sanitaryware

5517L003-



0075   

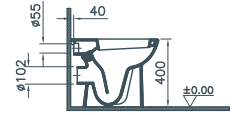
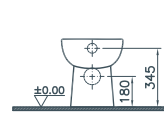
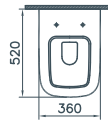

5518L003-



0075   

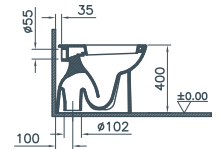
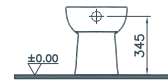
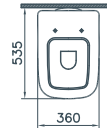

5520L003-



0075  

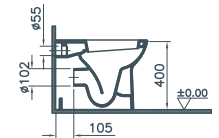
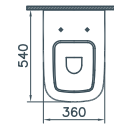

A 5510L003-

B 5514L003-



A 0075  

B 5042  

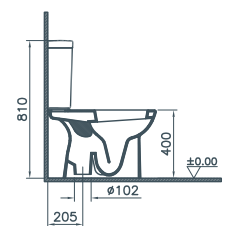
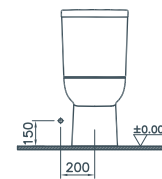
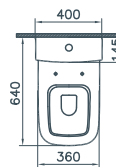



# Sanitärkeramik / Ceramic sanitaryware

A 5511L003-

B 5514L003-



- A 0075 
- B 5042 

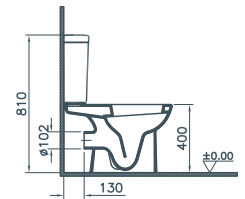
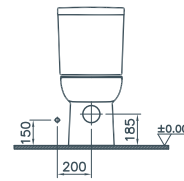
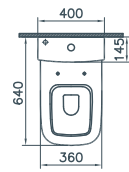

5298L003-



- 0075 

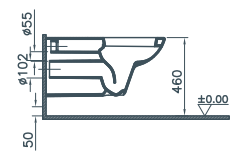
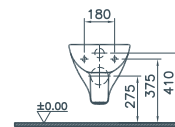
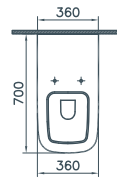

5296L003-



- 0075 

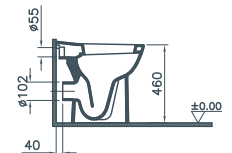
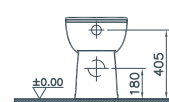
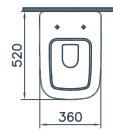

5297L003-



- 0075 

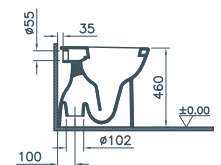
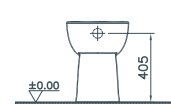
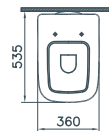





# Sanitärkeramik / Ceramic sanitaryware

A 5293L003-

B 5422L003-



- A 0585  
- B 5042  

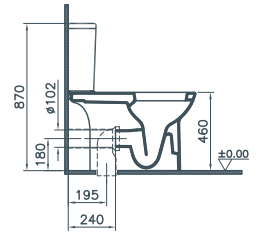
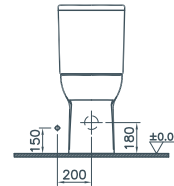
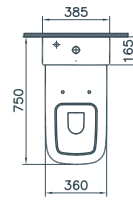

77-003-



- 001 
- 009 

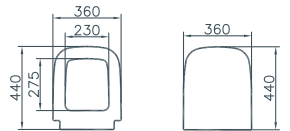

5508L003-



- 0288 

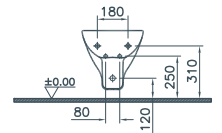
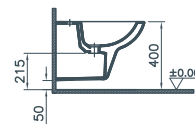
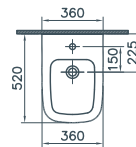

# Sanitärkeramik / Ceramic sanitaryware

5461B003D



0199 

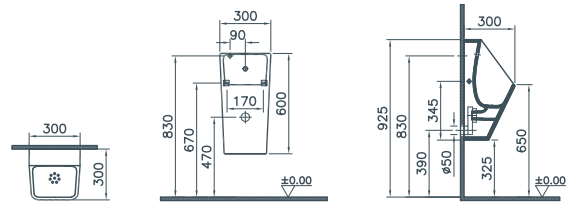

5462B003D



0198 

0199 

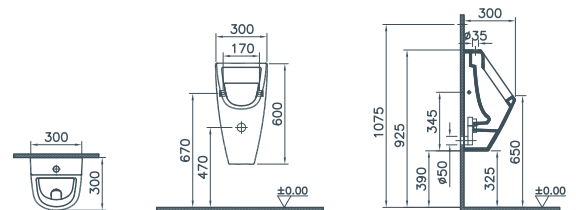



# Badmöbel/*Furniture*

## Waschtischunterschrank/*Vanity unit*

570 x 420 x 480 mm



- 82101  Weiß/*White*
- 82102  Anthrazit/*Anthracite*
- 82103  Kirschbaum dunkel/*Cherry tree dark*
- 82104  Eiche dunkel/*Oak dark*
- 82105  Hazienta black/*Hazienta black*

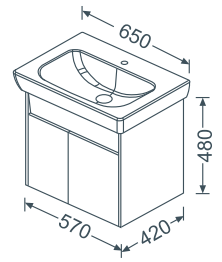

570 x 420 x 480 mm

- 82111  Weiß/*White*
- 82112  Anthrazit/*Anthracite*
- 82113  Kirschbaum dunkel/*Cherry tree dark*
- 82114  Eiche dunkel/*Oak dark*
- 82115  Hazienta black/*Hazienta black*

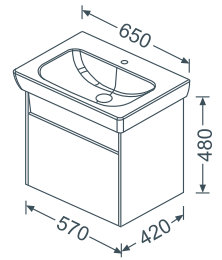

## Waschtischunterschrank/*Vanity unit*

770 x 420 x 480 mm



- 82121  Weiß/*White*
- 82122  Anthrazit/*Anthracite*
- 82123  Kirschbaum dunkel/*Cherry tree dark*
- 82124  Eiche dunkel/*Oak dark*
- 82125  Hazienta black/*Hazienta black*

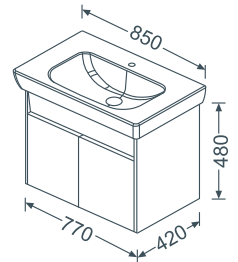

770 x 420 x 480 mm

- 82131  Weiß/*White*
- 82132  Anthrazit/*Anthracite*
- 82133  Kirschbaum dunkel/*Cherry tree dark*
- 82134  Eiche dunkel/*Oak dark*
- 82135  Hazienta black/*Hazienta black*

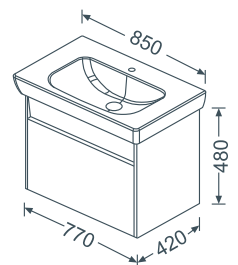



# Badmöbel/Furniture

## Hochschrank/Tall unit

350 x 350 x 1600 mm



- 82141  Weiß/White
- 82142  Anthrazit/Anthracite
- 82143  Kirschbaum dunkel/Cherry tree dark
- 82144  Eiche dunkel/Oak dark
- 82145  Hazienta black/Hazienta black

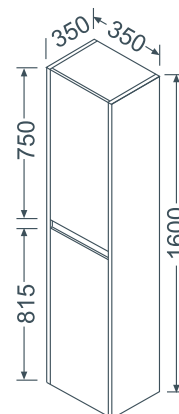

350 x 350 x 1600 mm

- 82151  Weiß/White
- 82152  Anthrazit/Anthracite
- 82153  Kirschbaum dunkel/Cherry tree dark
- 82154  Eiche dunkel/Oak dark
- 82155  Hazienta black/Hazienta black

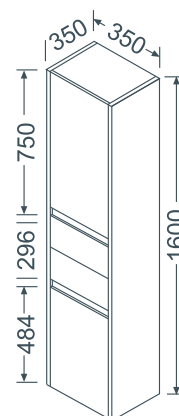

## Spiegel/Mirror

500 x 40 x 700 mm



82161      Grau/Grey

600 x 40 x 700 mm

82162      Grau/Grey

800 x 40 x 700 mm

82163      Grau/Grey

1000 x 40 x 700 mm

82164      Grau/Grey

1200 x 40 x 700 mm

82165      Grau/Grey

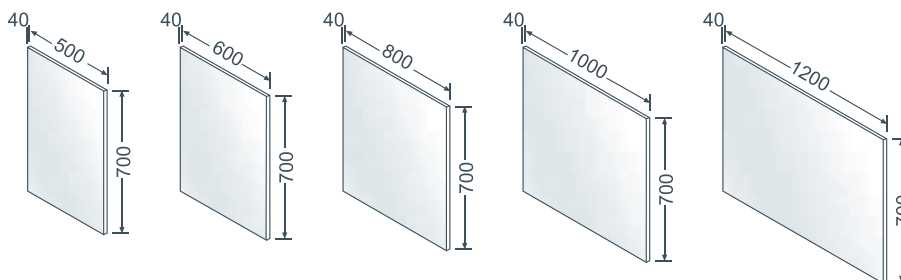

# Badmöbel/Furniture

## Spiegelablage/Mirror shelf

500 x 19 x 700 mm

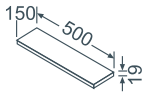

- 82171 Weiß/White
- 82172 Anthrazit/Anthracite
- 82173 Kirschbaum dunkel/Cherry tree dark
- 82174 Eiche dunkel/Oak dark
- 82175 Hazienta black/Hazienta black

500 x 19 x 700 mm

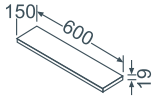

- 82181 Weiß/White
- 82182 Anthrazit/Anthracite
- 82183 Kirschbaum dunkel/Cherry tree dark
- 82184 Eiche dunkel/Oak dark
- 82185 Hazienta black/Hazienta black

500 x 19 x 700 mm

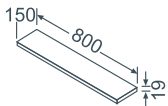

- 82191 Weiß/White
- 82192 Anthrazit/Anthracite
- 82193 Kirschbaum dunkel/Cherry tree dark
- 82194 Eiche dunkel/Oak dark
- 82195 Hazienta black/Hazienta black

500 x 19 x 700 mm

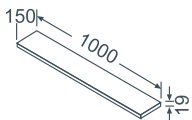

- 82201 Weiß/White
- 82202 Anthrazit/Anthracite
- 82203 Kirschbaum dunkel/Cherry tree dark
- 82204 Eiche dunkel/Oak dark
- 82205 Hazienta black/Hazienta black

500 x 19 x 700 mm

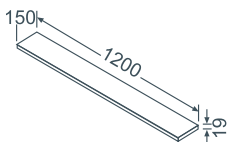

- 82211 Weiß/White
- 82212 Anthrazit/Anthracite
- 82213 Kirschbaum dunkel/Cherry tree dark
- 82214 Eiche dunkel/Oak dark
- 82215 Hazienta black/Hazienta black

## Aufsatzleuchte/Pole-top lantern

500 x 40 x 700 mm



- 82100   Chrom/Chrome

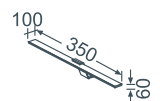

# Badmöbel/Furniture

## Spiegelschrank/Mirror cabinet

600 x 150 x 700 mm

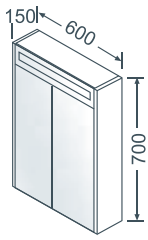

- 82221 Weiß/White
- 82222 Anthrazit/Anthracite
- 82223 Kirschbaum dunkel/Cherry tree dark
- 82224 Eiche dunkel/Oak dark
- 82225 Hazienta black/Hazienta black

800 x 150 x 700 mm

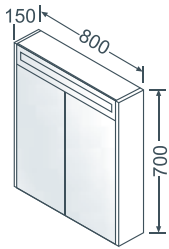

- 82231 Weiß/White
- 82232 Anthrazit/Anthracite
- 82233 Kirschbaum dunkel/Cherry tree dark
- 82234 Eiche dunkel/Oak dark
- 82235 Hazienta black/Hazienta black

1000 x 150 x 700 mm

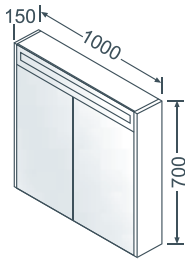

- 82241 Weiß/White
- 82242 Anthrazit/Anthracite
- 82243 Kirschbaum dunkel/Cherry tree dark
- 82244 Eiche dunkel/Oak dark
- 82245 Hazienta black/Hazienta black

1200 x 150 x 700 mm

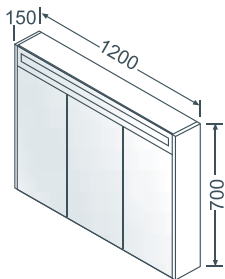



- 82251 Weiß/White
- 82252 Anthrazit/Anthracite
- 82253 Kirschbaum dunkel/Cherry tree dark
- 82254 Eiche dunkel/Oak dark
- 82255 Hazienta black/Hazienta black





# Symbole/Symbols

## Hahnloch/Tap hole

-  1 durchgestochen/1 punched out
-  ohne/without





## Überlaufloch/Overflow hole

-  mit/with
-  ohne/without



## Waschtisch / Washbasin

-  Aufsatz wandgebunden/Counter wall-mounted





## WC/WC

-  Spülung tief/Wash out
-  Spülung flach/Wash down
-  Spülvolumen 2,5/4 l/Flushing 2.5/4 l
-  Spülvolumen 3/6 l/Flushing 3/6 l



## WC-Sitz/WC seat

-  mit Absenkautomatik/with soft closing mechanism
-  ohne Absenkautomatik/without soft closing mechanism



## Abgang WC/Outlet close couple WC

-  vertikal/vertical
-  horizontal/horizontal
-  außen/open back
-  innen/back to wall



## Spülkastenanschluss/Cistern connection

-  hinten/back
-  seitlich/side





## Bidet/Bidet

-  mit seitlichen Löchern/with side holes
-  ohne seitliche Löcher/without side holes

## Urinal/Urinal

-  Zulauf oben/top inlet
-  Zulauf hinten/rear inlet



## Ausstattung/Equipment

-  Türanschlag rechts/Door fixation right
-  Türanschlag links/Door fixation left
-  Auszüge/Drawers
-  Einlegeböden/Shelves
-  Steckdosen/Power outlets



## Ausschnitt/Cutout

-  links/left
-  rechts/right
-  mittig/centre





## Beleuchtung/Lighting

-  Leuchtstoff/Fluorescent tube
-  Watt/W

## Montage/Installation

-  Wand/Wall-mounted
-  bodenstehend/floor-standing

## Sonstiges/Others

-  Netzanschluss/mains connection
-  Batterie/Long-life battery
-  Schalter/switch
-  LED/LED
-  Watt/W

## Maßangaben/Measurements

Badmöbel/Furniture B x T x H / W x D x H

# Farben/Colours

## Sanitärkeramik/Ceramic sanitaryware



003 Weiß/White

## Badmöbel/Furniture



Weiß, hochglänzend/  
White, high gloss

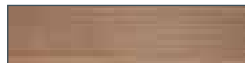

Kirschbaum dunkel, Dekor/  
Cherry tree dark, decor



Eiche dunkel, Dekor/  
Oak dark, decor



Anthrazit, hochglänzend/  
Antracite, high gloss



Hazienda Schwarz/  
Hacienda black

# VitrA

We reserve the right to make technical modifications and alter colours without prior notice.

VitrA Bad GmbH  
Agrippinawerft 24  
D-50678 K ln  
Tel. +49 221 277 368-0  
Fax +49 221 277 368-500  
info@vitra-bad.de  
vitra-bad.de · vitra-studio.de

 **Eczacıbaşı**